

Válvula desviadora, accionam. neumático valv. valves 3 way pneumatic diverter constant opening



Descripción Description

Válvula desviadora de caudal con accionamiento neumática para operar desde y la cabina del vehículo.

Circuit selector valve with pneumatic shifting to operate from the cabin of the vehicle.

Datos Principales Main Data

Código Part Number	901011	901111	
Presión Máx. Maximum pressure	350 bar		
Presión máxima para trabajo de corredera. Maximum pressure to working slide	250 bar		
Caudal Máximo Maximum flow	200 L/min	150 L/min	
Presión de aire Air pressure	7-10 bar		
Dimensiones Dimensions	A	217	196
	B	110	80
	C	72	64
	D	1" GAS	3/4" GAS

Dimensiones Dimensions

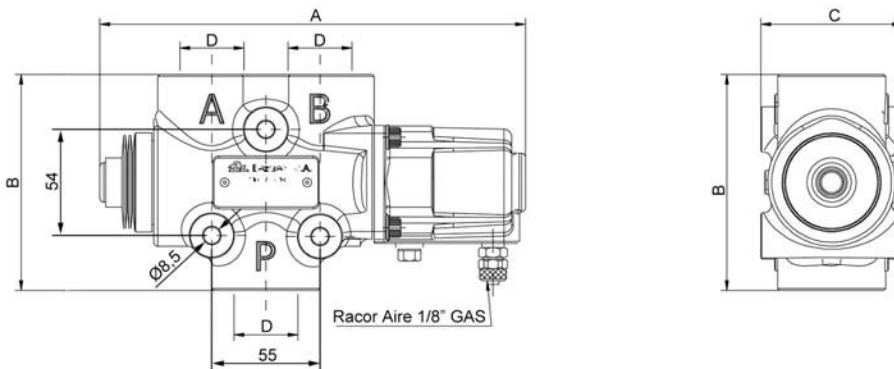

Esquemas hidráulicos Hydraulic Diagrams

